

## BRP Can-Am / Commander 1000 XT-P

**No:** 2444.7219.1  
**Brend:** BRP Can-Am  
**Model:** Commander 1000 XT-P  
**Year:** 2015-  
**Material:** Al - 4 mm



### Content

1. Plate 1.....	1 pc	14. Countersunk washer 6...	24 pc
2. Plate 2.....	1 pc	15. Countersunk washer 8...	16 pc
3. Plate 3.....	1 pc		
4. Sliders.....	2 pc		
5. Front CV guards.....	2 pc		
6. Insert nut.....	2 pc		
7. Bracket.....	4 pc		
8. Bracket.....	2 pc		
9. Bracket.....	2 pc		
10. Bolt M6x25.....	24 pc		
11. Screw M6x25.....	2 pc		
12. Bolt M8x25.....	16 pc		
13. Washer 6.....	4 pc		

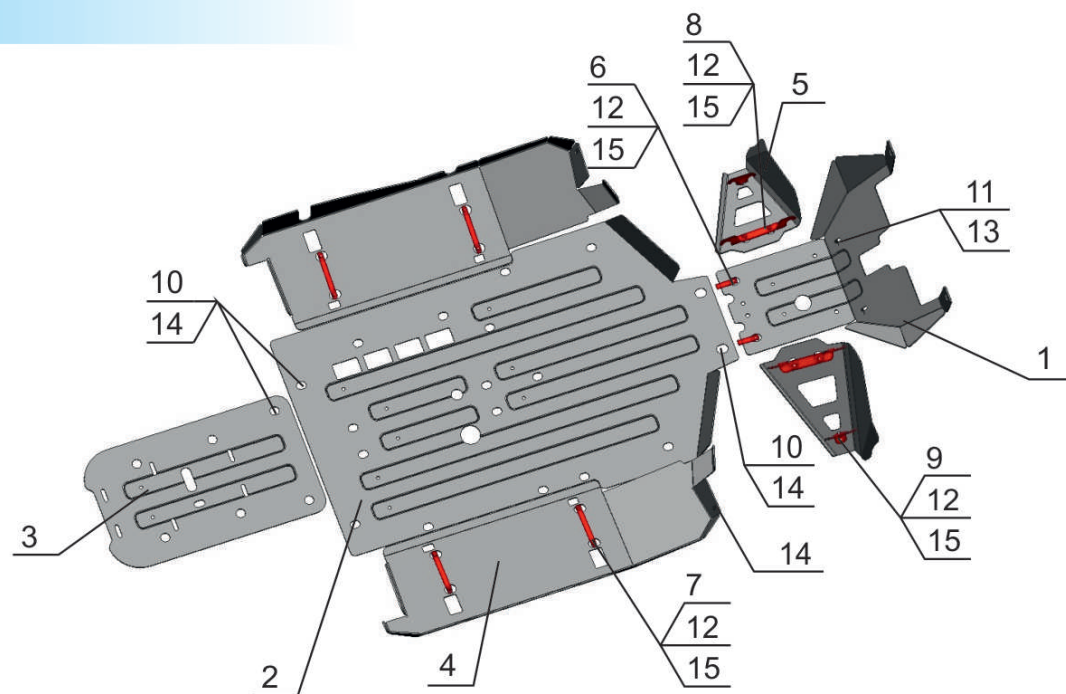

### Installation Instructions

1. Put ATV up. Remove factory plastic guards.
2. Place front end of plate 1 under stock bumper. Fix plate 1 to insert nuts no.6 and to original threaded holes with bolts no. 12, screws no.11 and washers no. 13, 15.
3. Cut thread M6 in original fitting holes without thread. Mount plate 2, 3 to original threaded holes with bolts no. 10 and washers no. 14.
4. Fix front end of sliders 4 with original screw with washer no. 14. Fix sliders 4 to brackets no.7 with bolts no. 12 and washers no. 15.
5. Mount front CV guards no. 5 to brackets no.8, 9 with bolts no. 12 and washers no. 15.
6. Tighten all screws.

### TOOLS REQUIRED



### TOOLS REQUIRED



M6-10 Nm



M8-30 Nm



M10-50 Nm

### FRONT ARM GUARDS

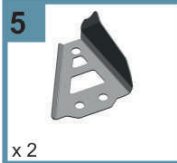

Bolt M8x25 - 6 pc  
Countersunk washer 8 - 6 pc

### FRONT REDUCER GUARD

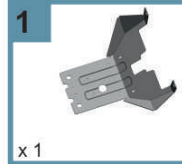

Screw M6x25 - 2 pc  
Bolt M6x25 - 2 pc  
Washer 6 - 2 pc  
Countersunk washer 8 - 2 pc  
Insert nut - 2 pc

### ENGINE BLOCK GUARD

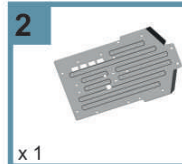

Bolt M6x25 - 18 pc  
Countersunk washer 6 - 18 pc

### BACK REDUCER GUARD

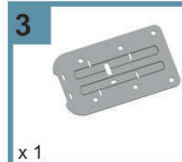

Bolt M6x25 - 6 pc  
Countersunk washer 6 - 6 pc

### SIDE GUARD

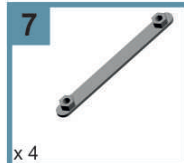
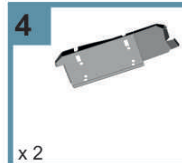

Bolt M8x25 - 8 pc  
Countersunk washer 8 - 8 pc  
Washer 6 - 2 pc