

EN DOOR KIT INSTALLATION MANUAL

DE MONTAGEEINLEITUNG TÜREN SET

RU ИНСТРУКЦИЯ ПО УСТАНОВКЕ ДВЕРЕЙ КВАДРОЦИКЛА



For: Polaris Ranger 1000 XP (2018-)

2444.7455.1
444.7455.1



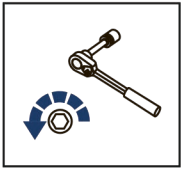

EN Regular fasteners
DE Originale montageteile
RU Штатный крепеж

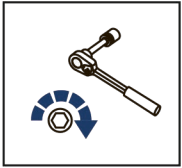

EN Regular fasteners
DE Originale montageteile
RU Штатный крепеж



EN Screw a several turns
DE Für wenigen Umdrehungen befestigen
RU Вкрутить на несколько оборотов

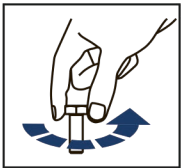

EN Loosen bolts
DE Bolzen lockern
RU Выкрутить на несколько оборотов

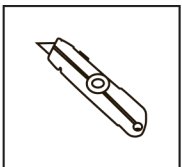

EN Office Knife
DE Büromesser
RU Канцелярский нож

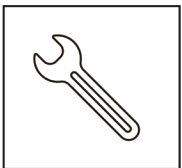

EN Wrench
DE Schraubenschlüssel
RU Гаечный ключ

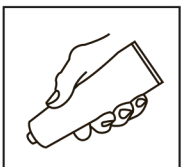

EN Grease
DE Schmierfett
RU Консистентная смазка

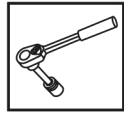

EN Ratchet
DE Ratsche
RU Трещётка

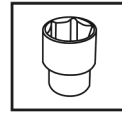



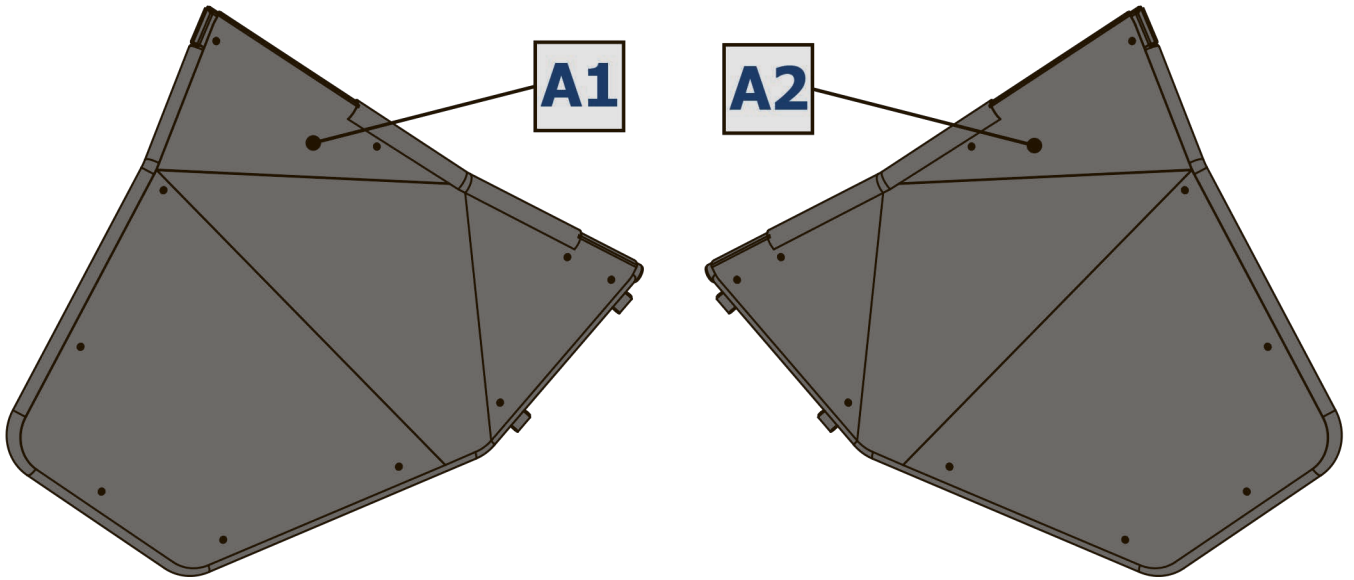



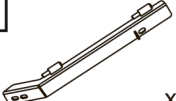
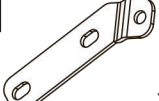
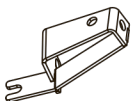

S - 10;
S - 17

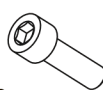

A1

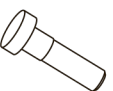
A2

1  x2	2  x2	3  x2	4  M8x20 x6	5  M6x20 x2	6  M6 x2
7  Ø8 x6	8  Ø6 x4	9  x2	10  M8 x4		

